

AP4606

N and P-Channel Enhancement Mosfet

Feature

- **N-Channel**

$V_{DD}=30V, I_D=7A$

$R_{DS(ON)} < 25m\Omega @ V_{GS}=10V$ TYP:18 mΩ

$R_{DS(ON)} < 38m\Omega @ V_{GS}=4.5V$ TYP:25 mΩ

- **P-Channel**

$V_{DD}=-30V, I_D=-6A$

$R_{DS(ON)} < 35m\Omega @ V_{GS}=-10V$ TYP:28 mΩ

$R_{DS(ON)} < 58m\Omega @ V_{GS}=-4.5V$ TYP:44 mΩ

- Lead free product is acquired
- High power and current handling capability
- Surface mount package

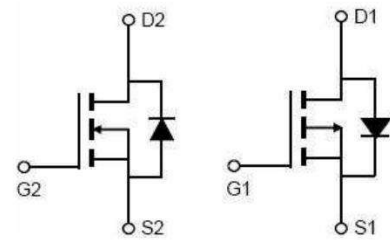

N-channel

P-channel

Schematic diagram

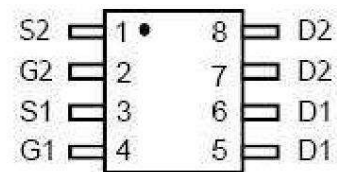

Marking and pin assignment

Application

- PWM applications
- Load Switch
- Power management

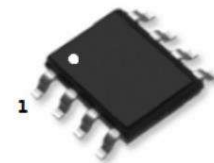

SOP-8

Package Marking and Ordering Information

Device Marking	Device	Device Package	Reel Size	Tape width	Quantity (PCS)
4606	AP4606	SOP-8	13 inch	-	4000

ABSOLUTE MAXIMUM RATINGS ($T_a=25^{\circ}C$ unless otherwise noted)

Parameter	Symbol	N-Channel	P-Channel	Unit
Drain-Source Voltage	V_{DS}	30	-30	V
Gate-Source Voltage	V_{GS}	± 20	± 20	V
Continuous Drain Current ($T_a = 25^{\circ}C$)	I_D	7	-6	A
Continuous Drain Current ($T_a = 100^{\circ}C$)	I_D	4.5	-4	A
Pulsed Drain Current ⁽¹⁾	I_{DM}	28	-24	A
Power Dissipation	P_D	2.15	2.15	W
Thermal Resistance from Junction to Ambient	$R_{\theta JA}$	58	58	$^{\circ}C/W$
Junction Temperature	T_J	150	150	$^{\circ}C$
Storage Temperature	T_{STG}	-55~ +150	-55~ +150	$^{\circ}C$

N-CH ELECTRICAL CHARACTERISTICS(T_a=25°C unless otherwise noted)

Parameter	Symbol	Test Condition	Min	Type	Max	Unit
Static Characteristics						
Drain-source breakdown voltage	V _{(BR)DSS}	V _{GS} = 0V, I _D = -250μA	30			V
Zero gate voltage drain current	I _{DSS}	V _{DS} = 30V, V _{GS} = 0V			1	μA
Gate-body leakage current	I _{GSS}	V _{GS} = ±20V, V _{DS} = 0V			±100	nA
Gate threshold voltage ⁽²⁾	V _{GS(th)}	V _{DS} = V _{GS} , I _D = 250μA	1	1.5	2.5	V
Drain-source on-resistance ⁽²⁾	R _{DS(on)}	V _{GS} = 10V, I _D = 5A		18	25	mΩ
		V _{GS} = 4.5V, I _D = 3A		25	38	
Dynamic characteristics						
Input Capacitance	C _{iss}	V _{DS} = 15V, V _{GS} = 0V, f = 1MHz		490		pF
Output Capacitance	C _{oss}			79		
Reverse Transfer Capacitance	C _{rss}			61		
Switching characteristics						
Turn-on delay time	t _{d(on)}	V _{DD} = 15V, I _D = 3A, R _L = 6Ω V _{GS} = 10V, R _G = 3Ω		4.5		ns
Turn-on rise time	t _r			2.5		
Turn-off delay time	t _{d(off)}			14.5		
Turn-off fall time	t _f			3.5		
Total Gate Charge	Q _g	V _{DS} = 15V, I _D = 5A, V _{GS} = 10V		5.2		nC
Gate-Source Charge	Q _{gs}			0.9		
Gate-Drain Charge	Q _{gd}			1.3		
Source-Drain Diode characteristics						
Diode Forward voltage ⁽²⁾	V _{DS}	V _{GS} = 0V, I _S = 7A			1.2	V
Diode Forward current ⁽³⁾	I _S		-	-	7	A

AP4606

N and P-Channel Enhancement Mosfet

P-CH ELECTRICAL CHARACTERISTICS($T_a=25^{\circ}\text{C}$ unless otherwise noted)

Parameter	Symbol	Test Condition	Min	Type	Max	Unit
Static Characteristics						
Drain-source breakdown voltage	$V_{(BR)DSS}$	$V_{GS} = 0V, I_D = -250\mu A$	-30			V
Zero gate voltage drain current	I_{DSS}	$V_{DS} = -30V, V_{GS} = 0V$			1	μA
Gate-body leakage current	I_{GSS}	$V_{GS} = \pm 20V, V_{DS} = 0V$			± 100	nA
Gate threshold voltage ⁽²⁾	$V_{GS(th)}$	$V_{DS} = V_{GS}, I_D = -250\mu A$	-1	-1.5	-2.5	V
Drain-source on-resistance ⁽²⁾	$R_{DS(on)}$	$V_{GS} = -10V, I_D = -4A$		28	35	m Ω
		$V_{GS} = -4.5V, I_D = -3A$		44	58	
Dynamic characteristics						
Input Capacitance	C_{iss}	$V_{DS} = -15V, V_{GS} = 0V, f = 1MHz$		580		pF
Output Capacitance	C_{oss}			98		
Reverse Transfer Capacitance	C_{rss}			74		
Switching characteristics						
Turn-on delay time	$t_{d(on)}$	$V_{DD} = -15V, I_D = -1A, R_L = 6\Omega$ $V_{GS} = -10V, R_G = 1\Omega$		14		ns
Turn-on rise time	t_r			61		
Turn-off delay time	$t_{d(off)}$			19		
Turn-off fall time	t_f			10		
Total Gate Charge	Q_g	$V_{DS} = -15V, I_D = -4.1A,$ $V_{GS} = -10V$		6.8		nC
Gate-Source Charge	Q_{gs}			1		
Gate-Drain Charge	Q_{gd}			1.4		
Source-Drain Diode characteristics						
Diode Forward voltage ⁽²⁾	V_{DS}	$V_{GS} = 0V, I_S = -4A$			1.2	V
Diode Forward current ⁽³⁾	I_S		-	-	-5.1	A

Notes:

1. Repetitive Rating: pulse width limited by maximum junction temperature
2. Pulse Test: pulse width $\leq 300\mu s$, duty cycle $\leq 2\%$
3. Surface Mounted on FR4 Board, $t \leq 10$ sec

N Test Circuit

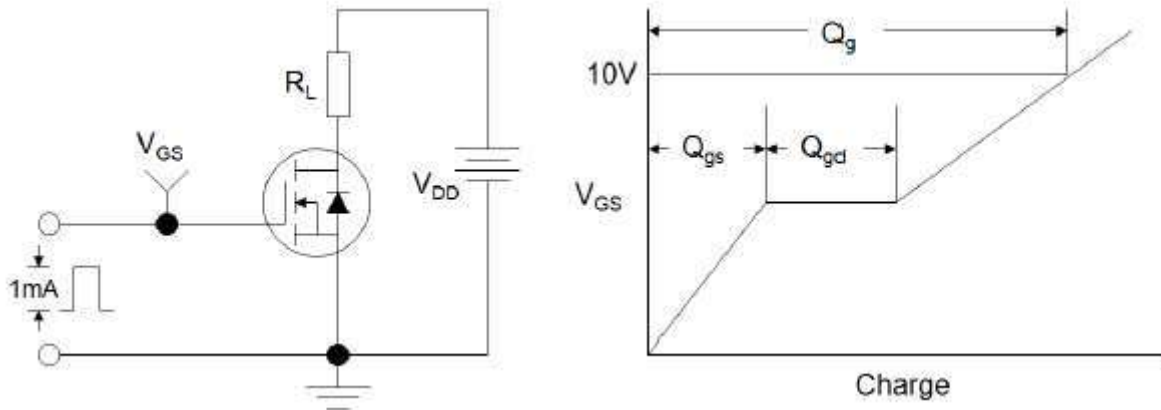

Figure1:Gate Charge Test Circuit & Waveform

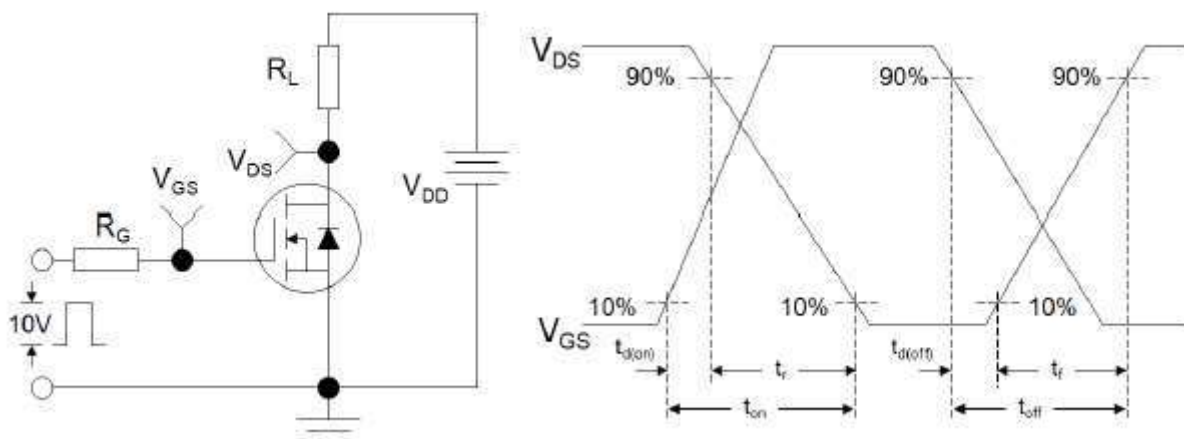

Figure 2: Resistive Switching Test Circuit & Waveforms

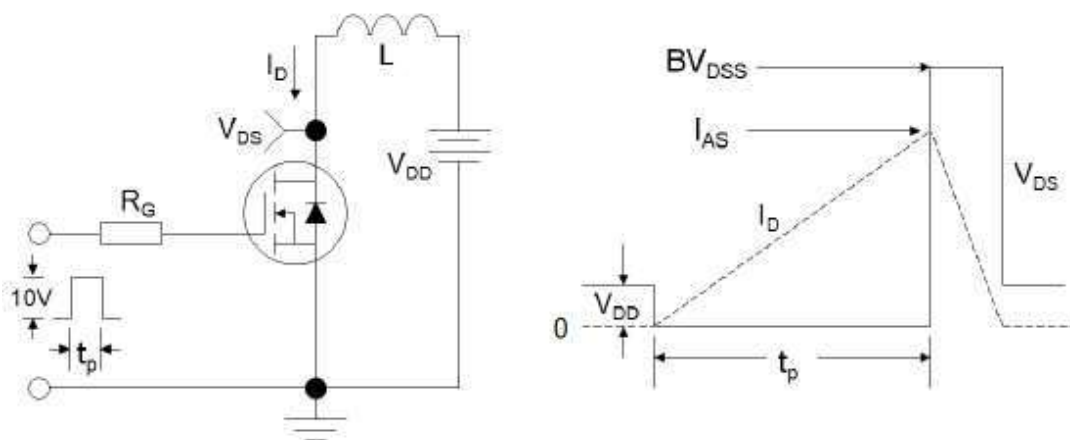

Figure 3:Unclamped Inductive Switching Test Circuit & Waveforms

Figure 1: Output Characteristics

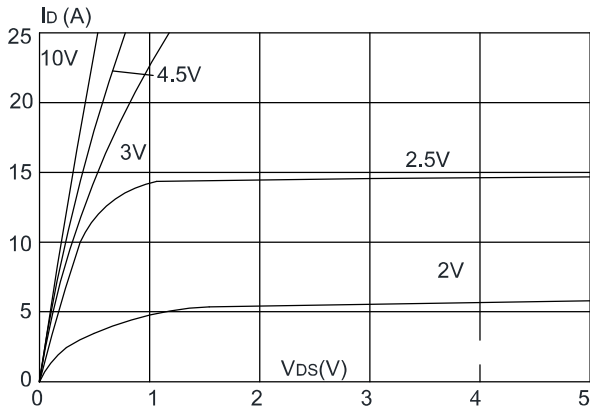

Figure 2: Typical Transfer Characteristics

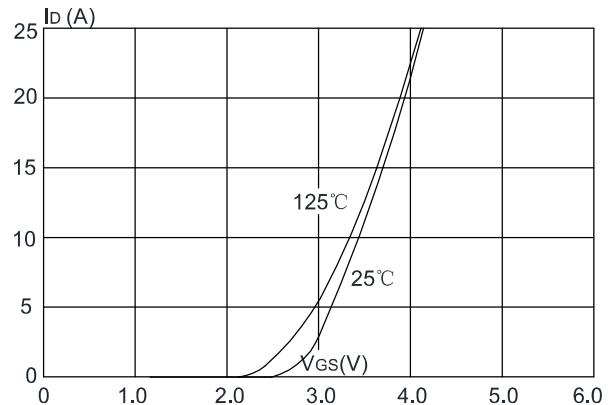

Figure 3: On-resistance vs. Drain Current

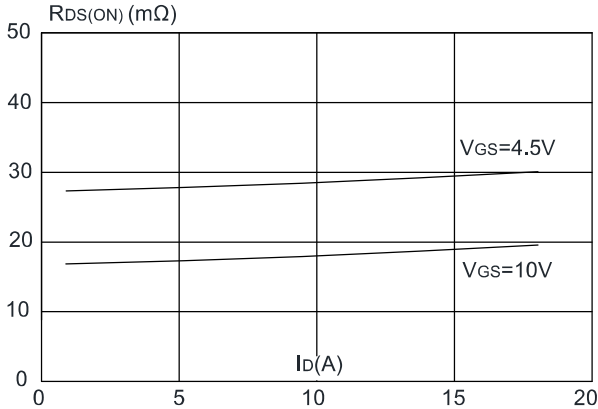

Figure 4: Body Diode Characteristics

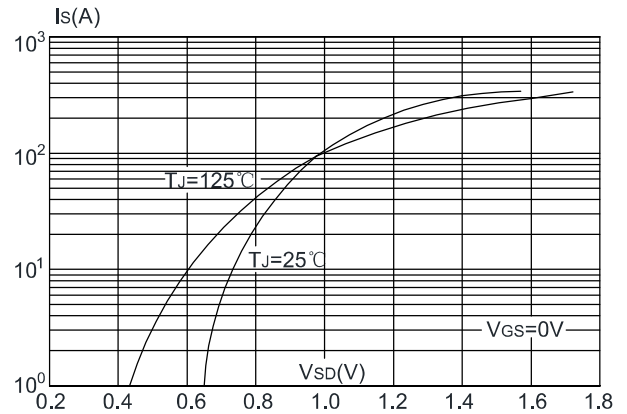

Figure 5: Gate Charge Characteristics

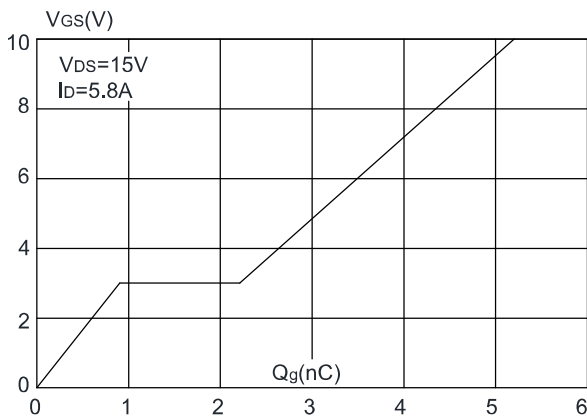

Figure 6: Capacitance Characteristics

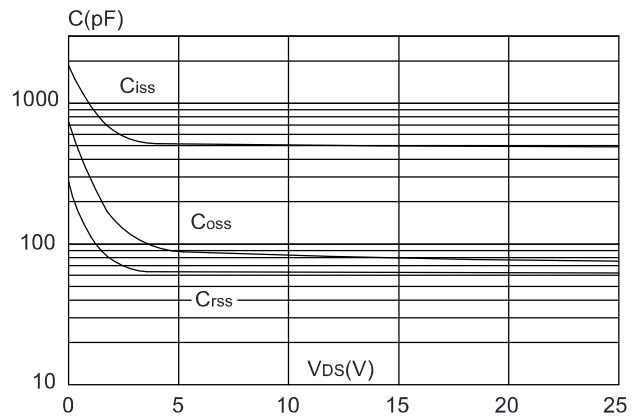

Figure 7: Normalized Breakdown Voltage vs. Junction Temperature

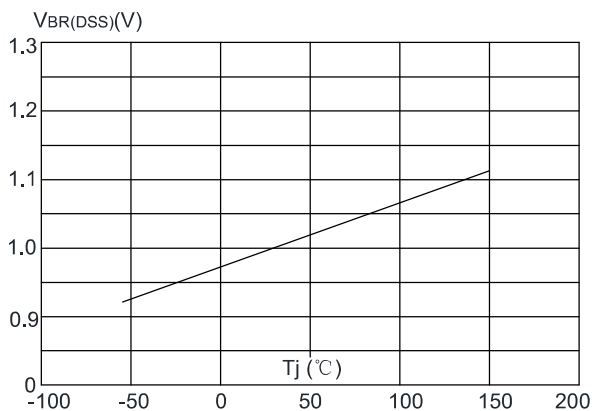

Figure 8: Normalized on Resistance vs. Junction Temperature

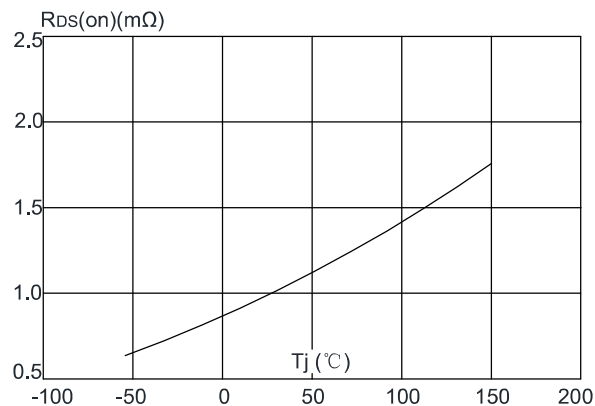

Figure 9: Maximum Safe Operating Area

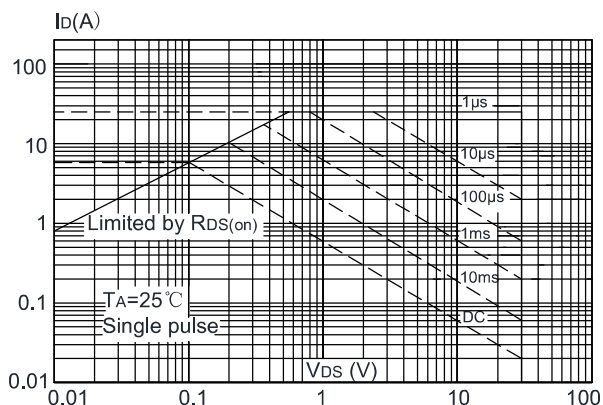

Figure 10: Maximum Continuous Drain Current vs. Ambient Temperature

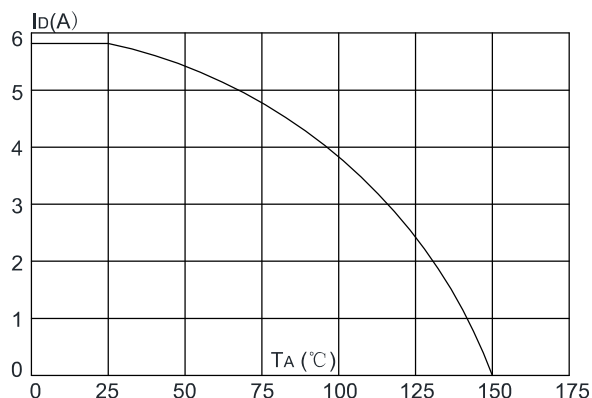
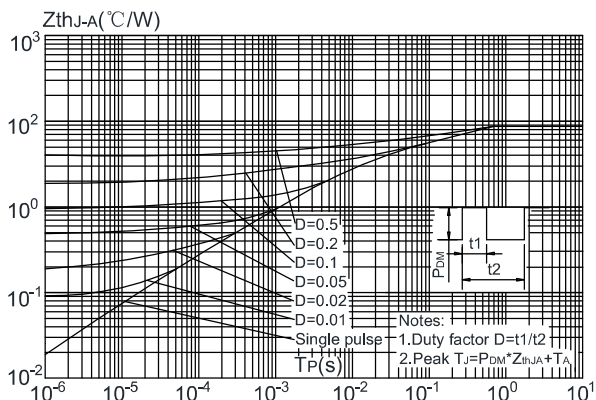
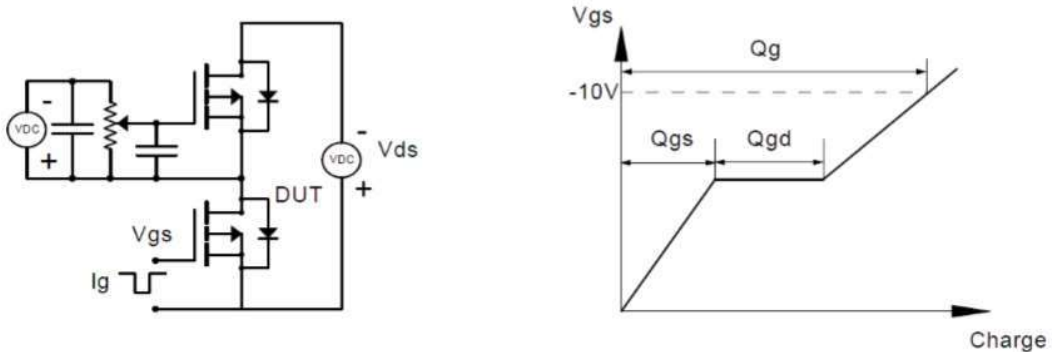

Figure.11: Maximum Effective Transient Thermal Impedance, Junction-to-Ambient



P Typical Performance Characteristics

Gate Charge Test Circuit & Waveform



Resistive Switching Test Circuit & Waveforms

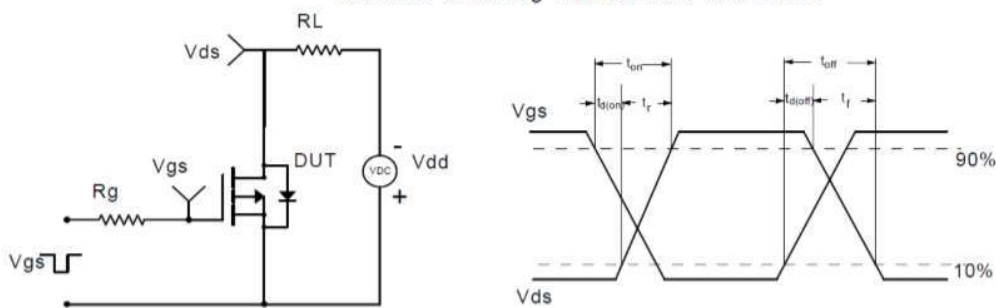

Unclamped Inductive Switching (UIS) Test Circuit & Waveforms

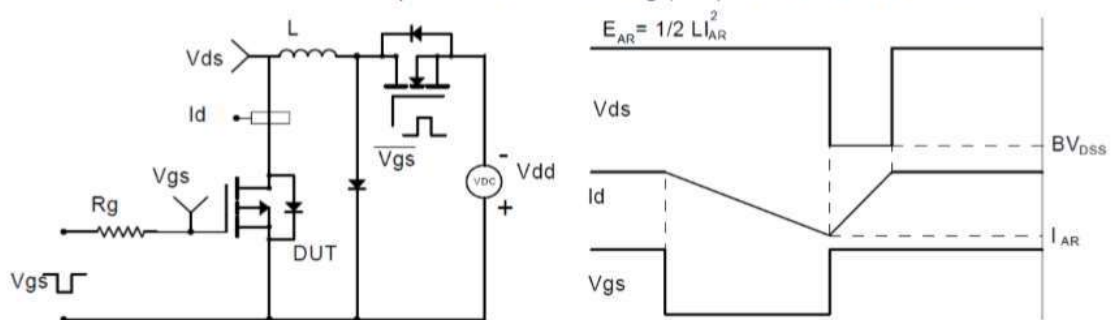

Diode Recovery Test Circuit & Waveforms

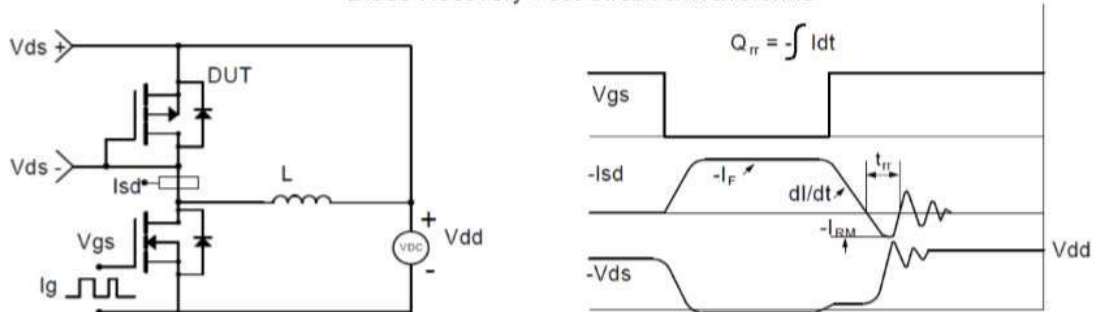

Figure 1: Output Characteristics

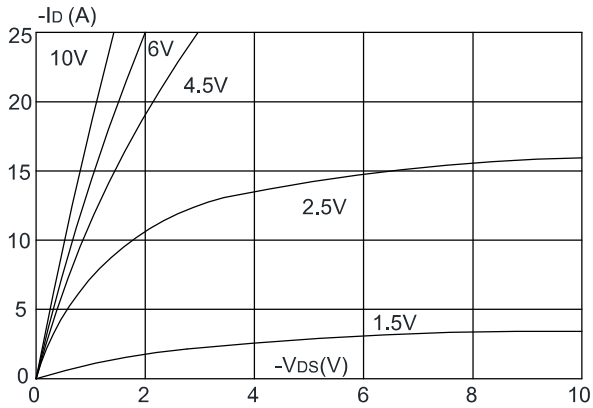

Figure 2: Typical Transfer Characteristics

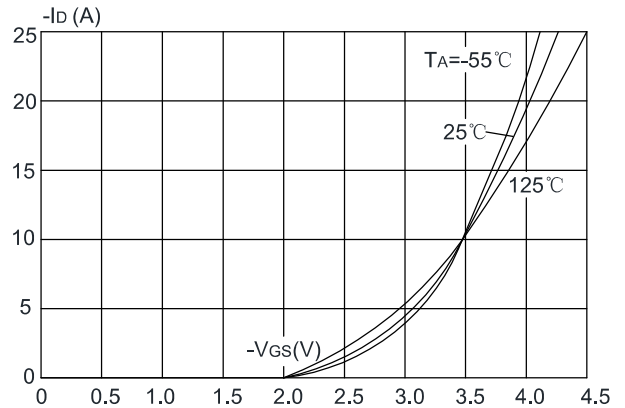

Figure 3: On-resistance vs. Drain Current

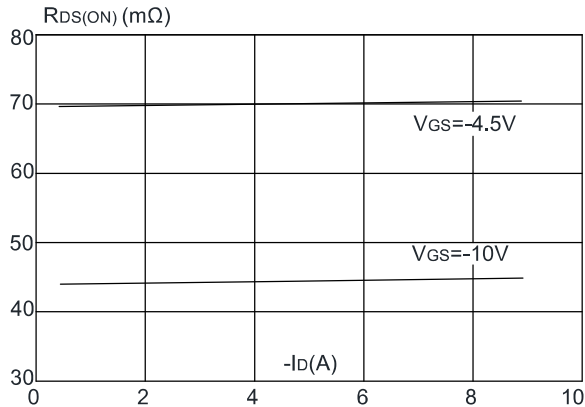

Figure 4: Body Diode Characteristics

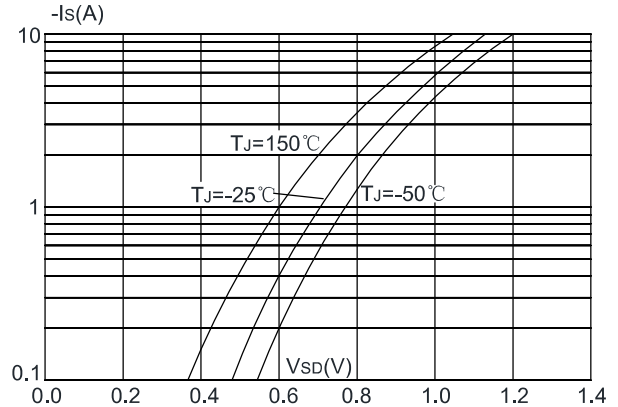

Figure 5: Gate Charge Characteristics

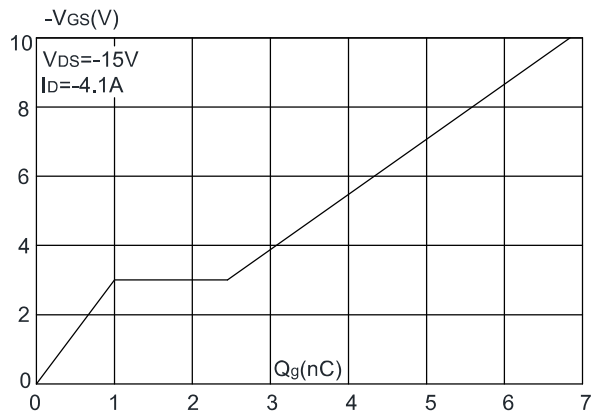

Figure 6: Capacitance Characteristics

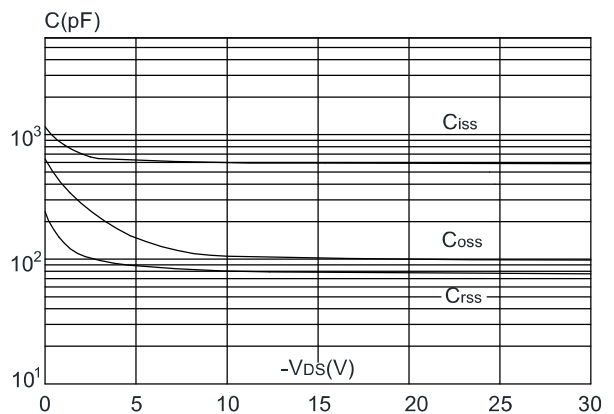

Figure 7: Normalized Breakdown Voltage vs. Junction Temperature

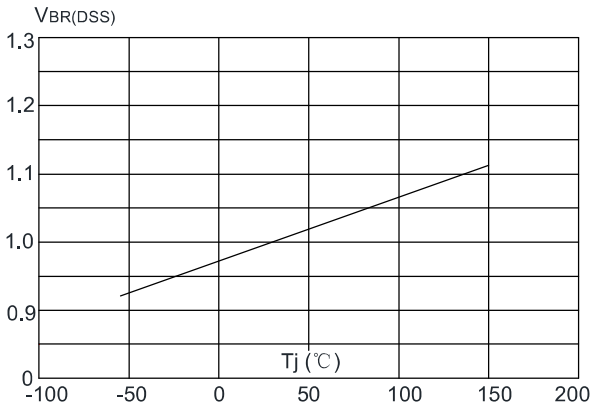

Figure 8: Normalized on Resistance vs. Junction Temperature

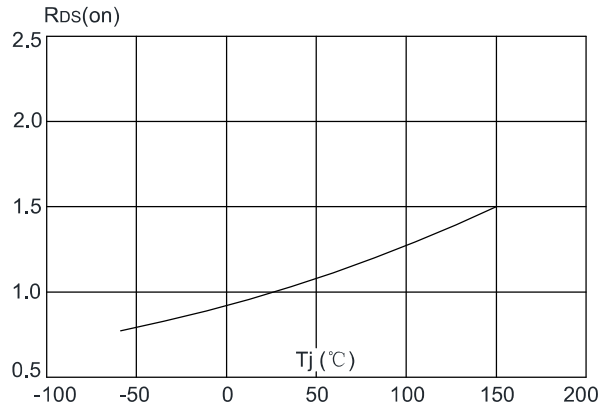

Figure 9: Maximum Safe Operating Area

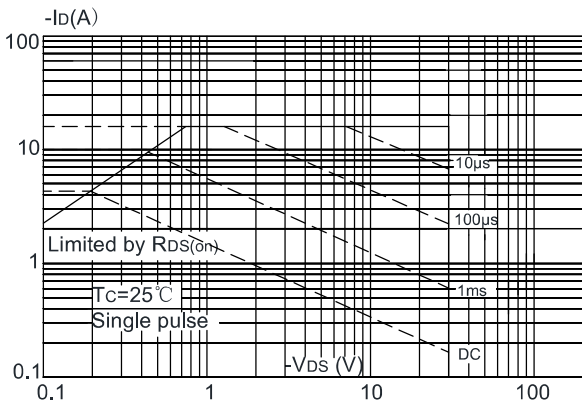

Figure 10: Maximum Continuous Drain Current vs. Ambient Temperature

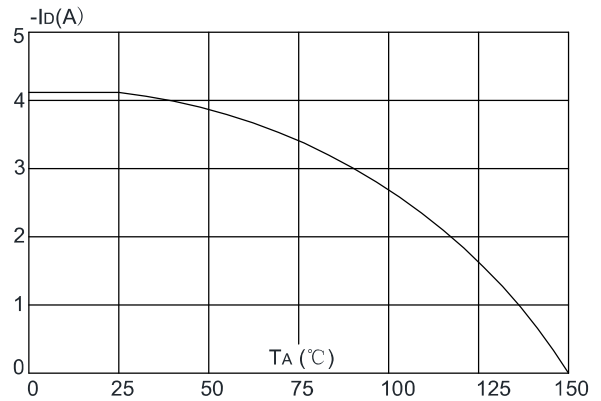
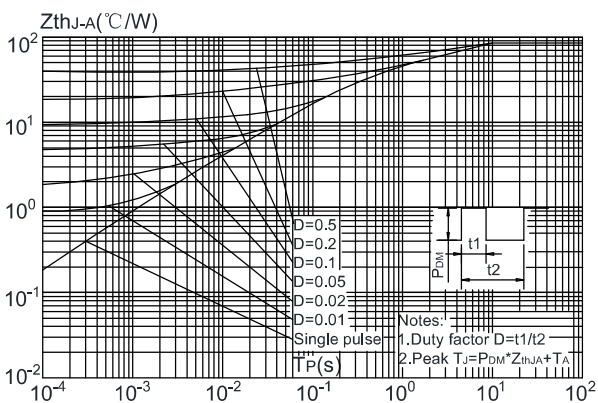
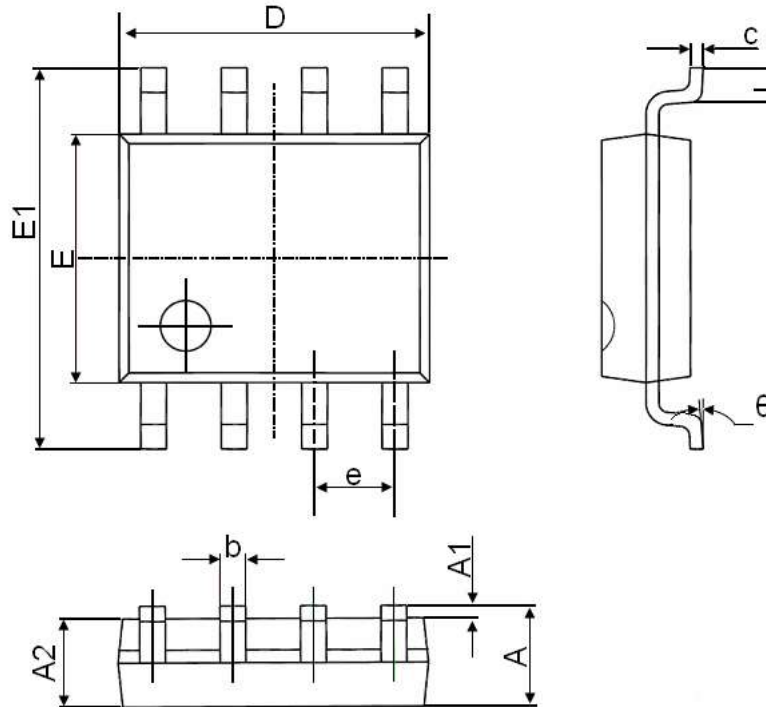

Figure.11: Maximum Effective Transient Thermal Impedance, Junction-to-Ambient



SOP-8 Package Information



Symbol	Dimensions In Millimeters		Dimensions In Inches	
	Min.	Max.	Min.	Max.
A	1.350	1.750	0.053	0.069
A1	0.100	0.250	0.004	0.010
A2	1.350	1.550	0.053	0.061
b	0.330	0.510	0.013	0.020
c	0.170	0.250	0.006	0.010
D	4.700	5.100	0.185	0.200
E	3.800	4.000	0.150	0.157
E1	5.800	6.200	0.228	0.244
e	1.270(BSC)		0.050(BSC)	
L	0.400	1.270	0.016	0.050
θ	0°	8°	0°	8°